

H = 1.500 m  
TOTAL: 72.20 m²

Code	Francia_Carrion	
Page	1	03.12.015
Drawing	Plan	
Scale	1:100	
File	Francia_Carrion.dwg	
Wall	44+90+19	

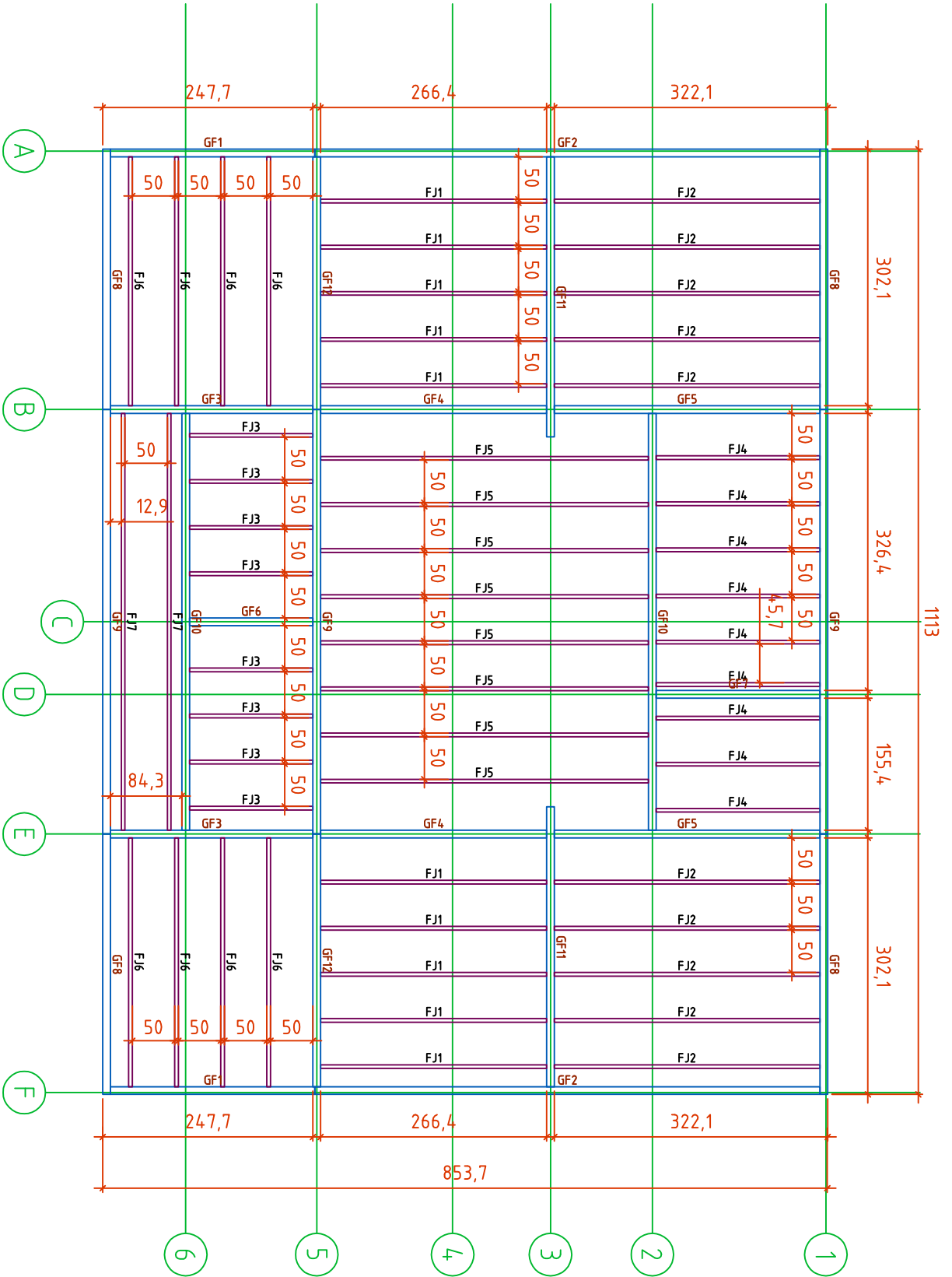

Code	Francia_Carrion		Page	1/1	03.12.015
Drawing	Ground frame		Scale	1:100	
File	Francia_Carrion.dwg				

Wall\_44+90+19

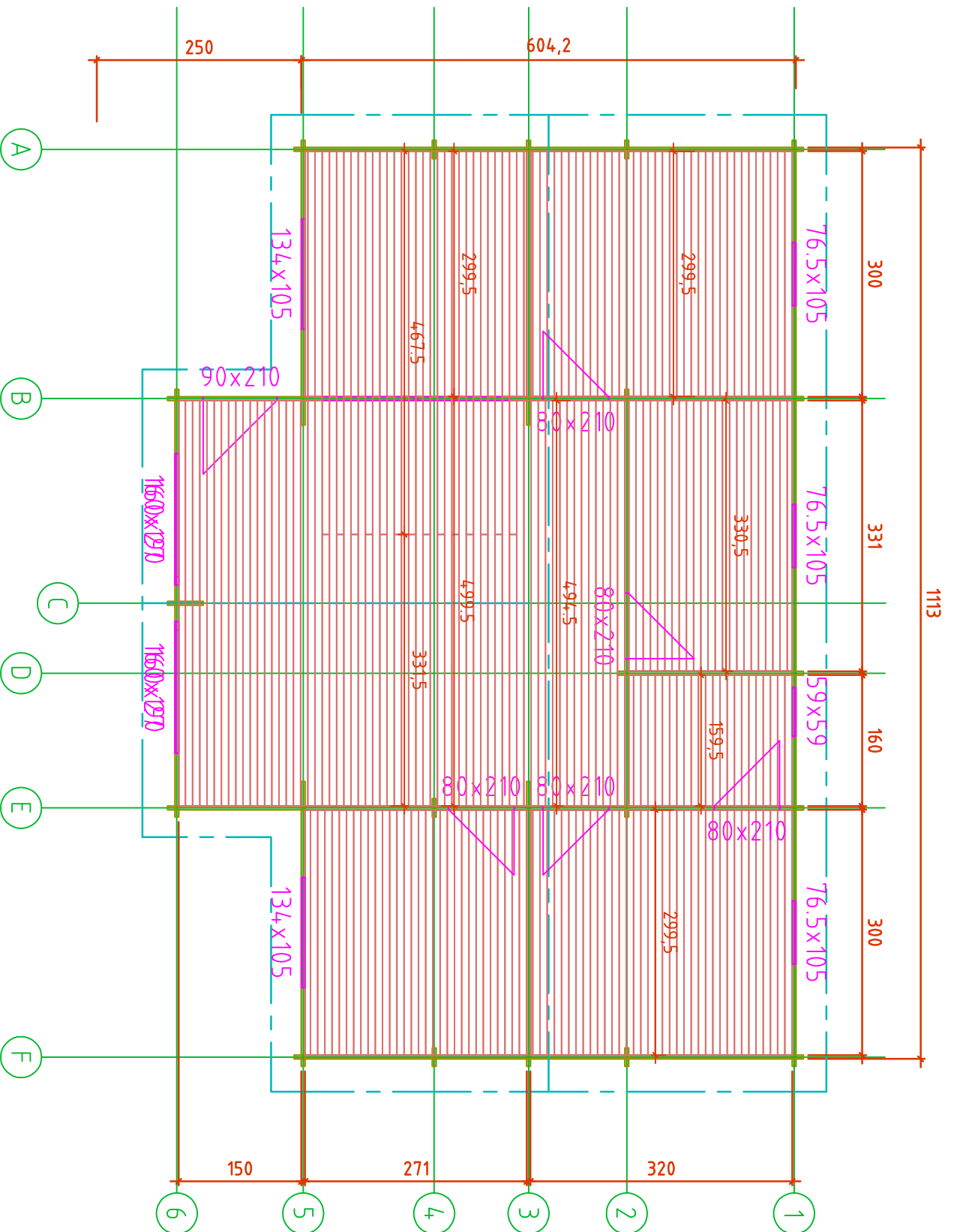

Code	Francia_Carrion	Page	1/2
Drawing	Floor board	Scale	1:100
File	Francia_Carrion.dwg		

Wall\_44+90+19

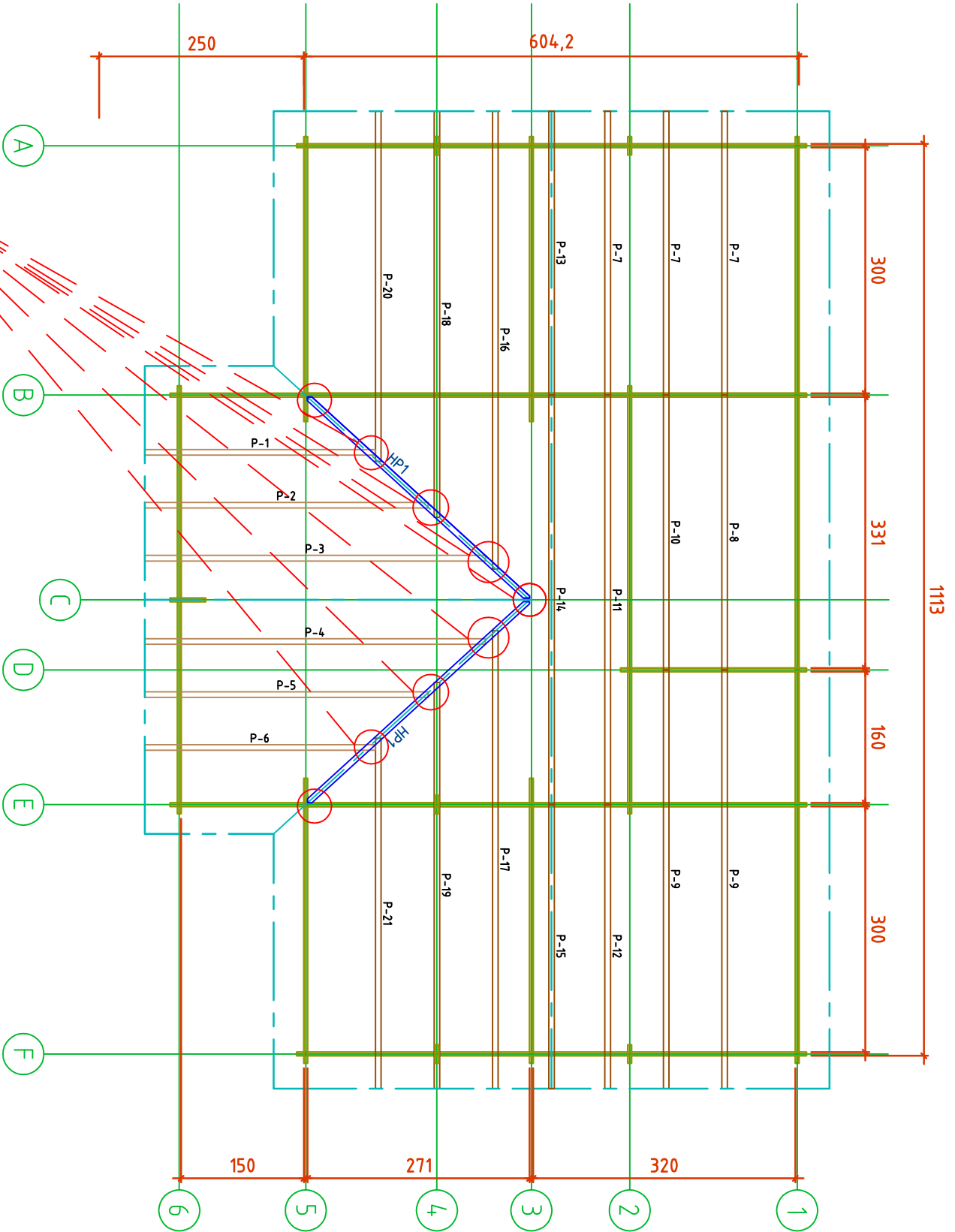

*Purl In & Hip rafters cut during installation*

Code	Francia_Carrion		Page	1/3
Drawing	Plan Purl in		Scale	1:100
File	Francia_Carrion.dwg			

Wall\_44+90+19











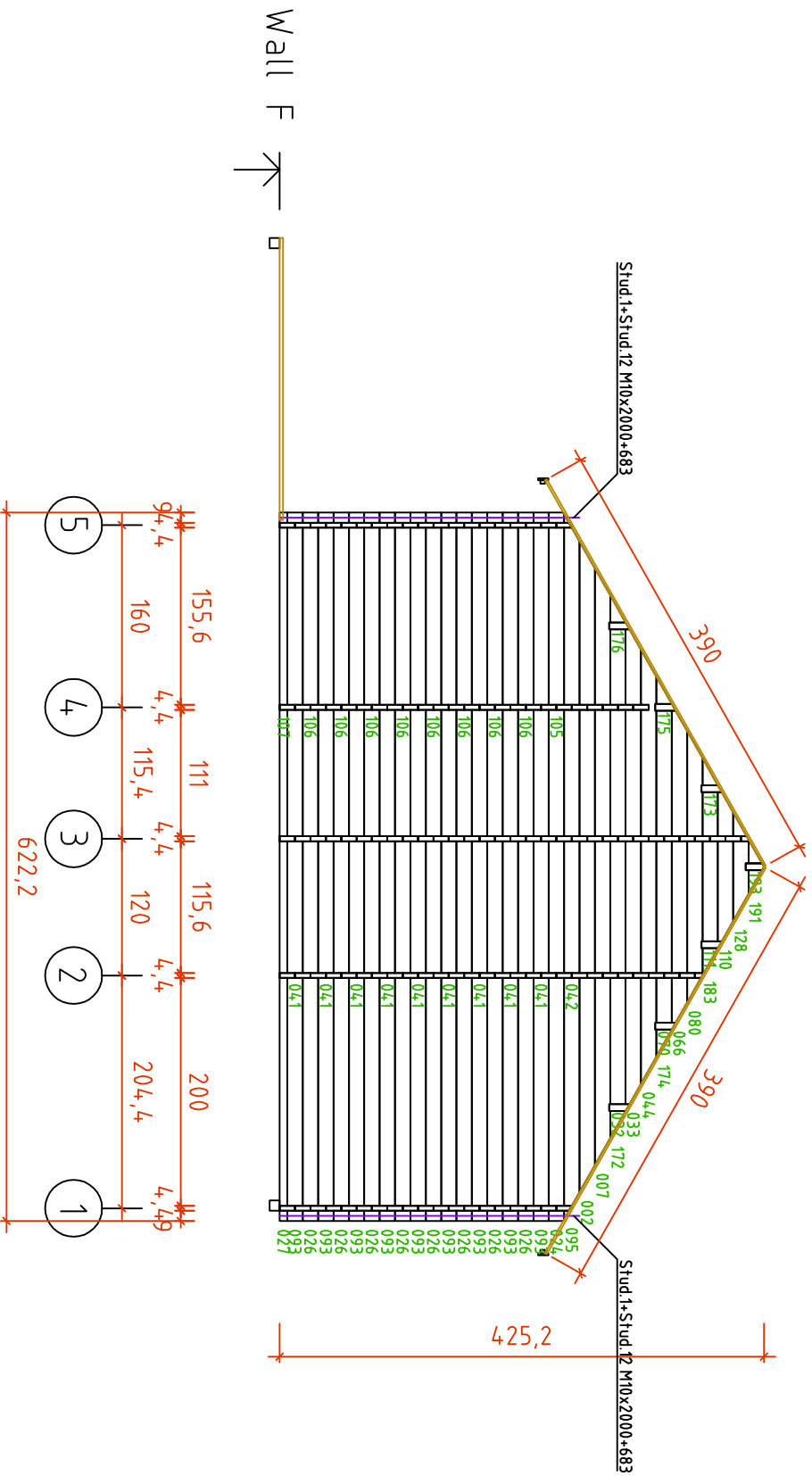

Wall F

Code	Francia_Carrion		Page	7	03.12.015
Drawing	WALL F		Scale	1:100	
File	Wall_44+90+19		File	Francia_Carrion.dwg	

Wall 1 ↗

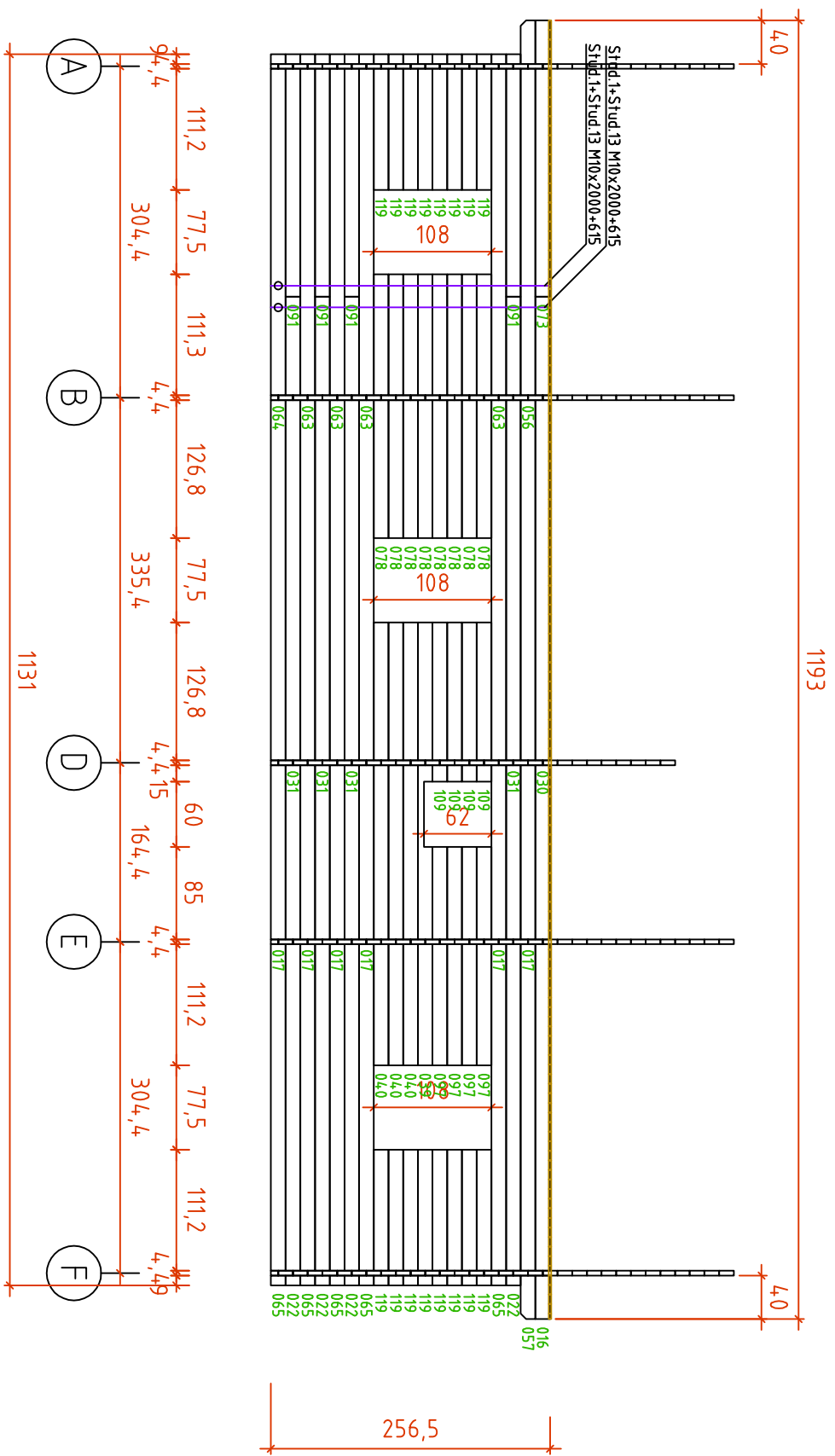





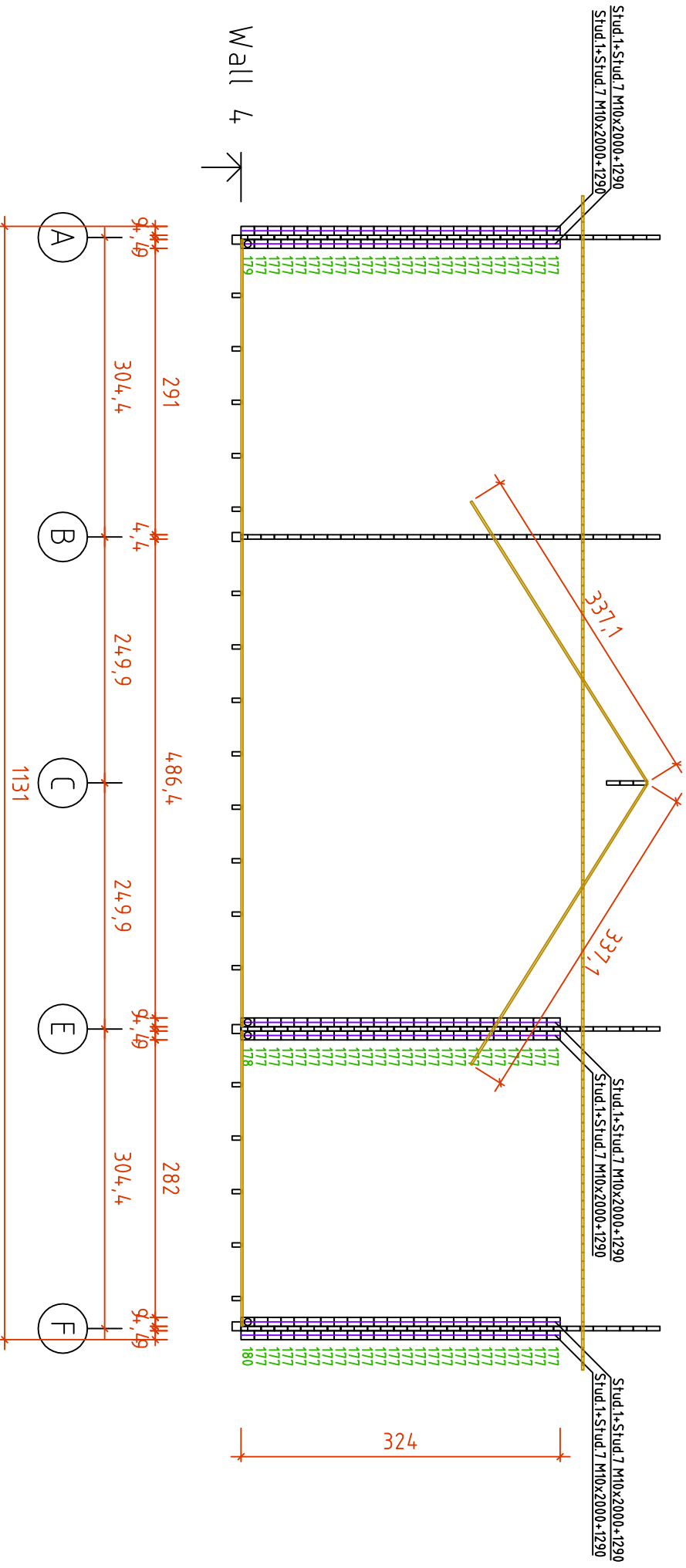

Code	Francia_Carrion		Page	11	03.12.015
Drawing	WALL 4		Scale	1:100	
File	Wall_44+90+19		File	Francia_Carrion.dwg	

Wall 5 ↗

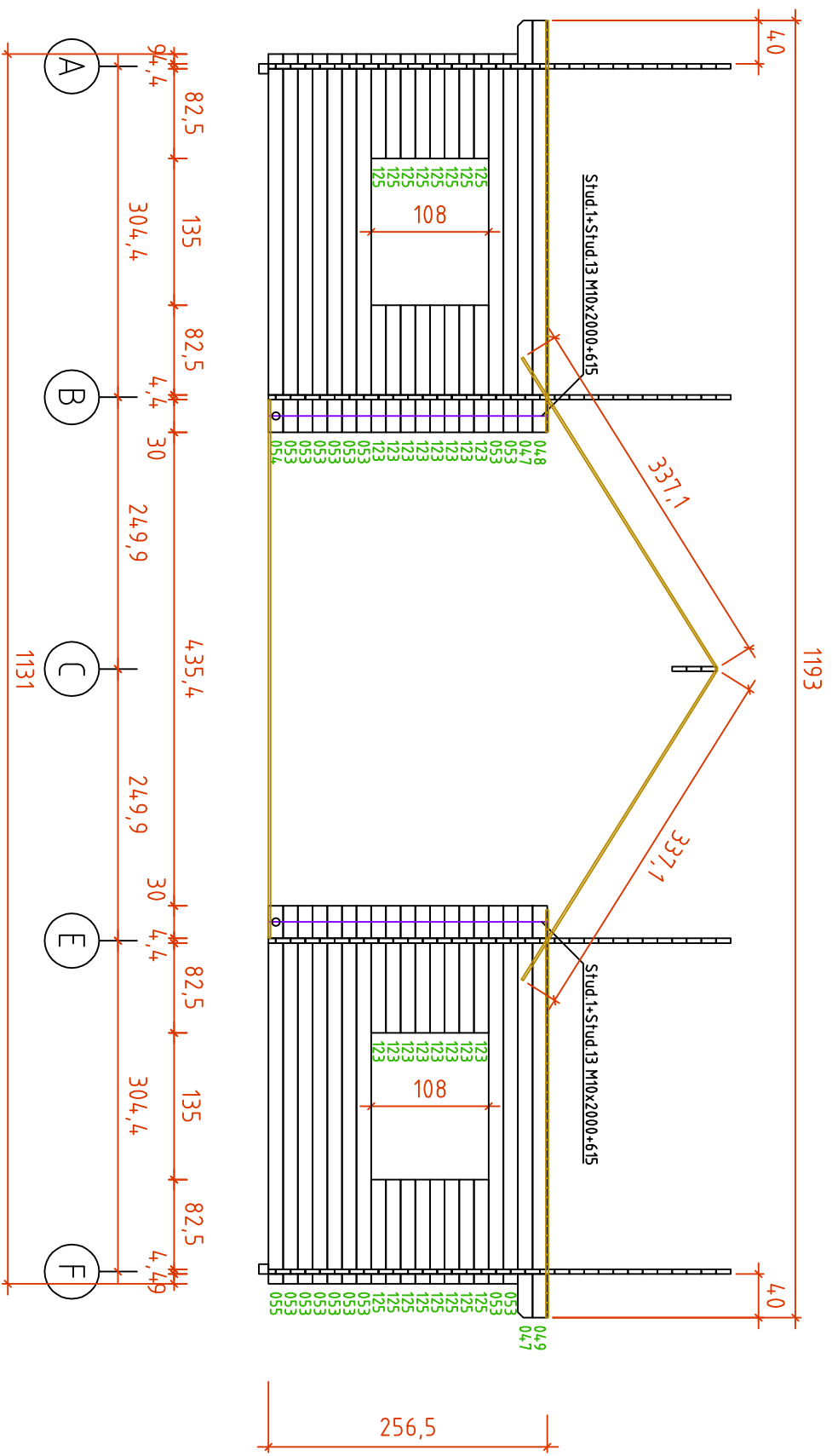

Code	Francia_Carrion		Page	12	03.12.015
Drawing	WALL 5		Scale	1:100	
File	Wall_44+90+19		File	Francia_Carrion.dwg	

11 6 ↗

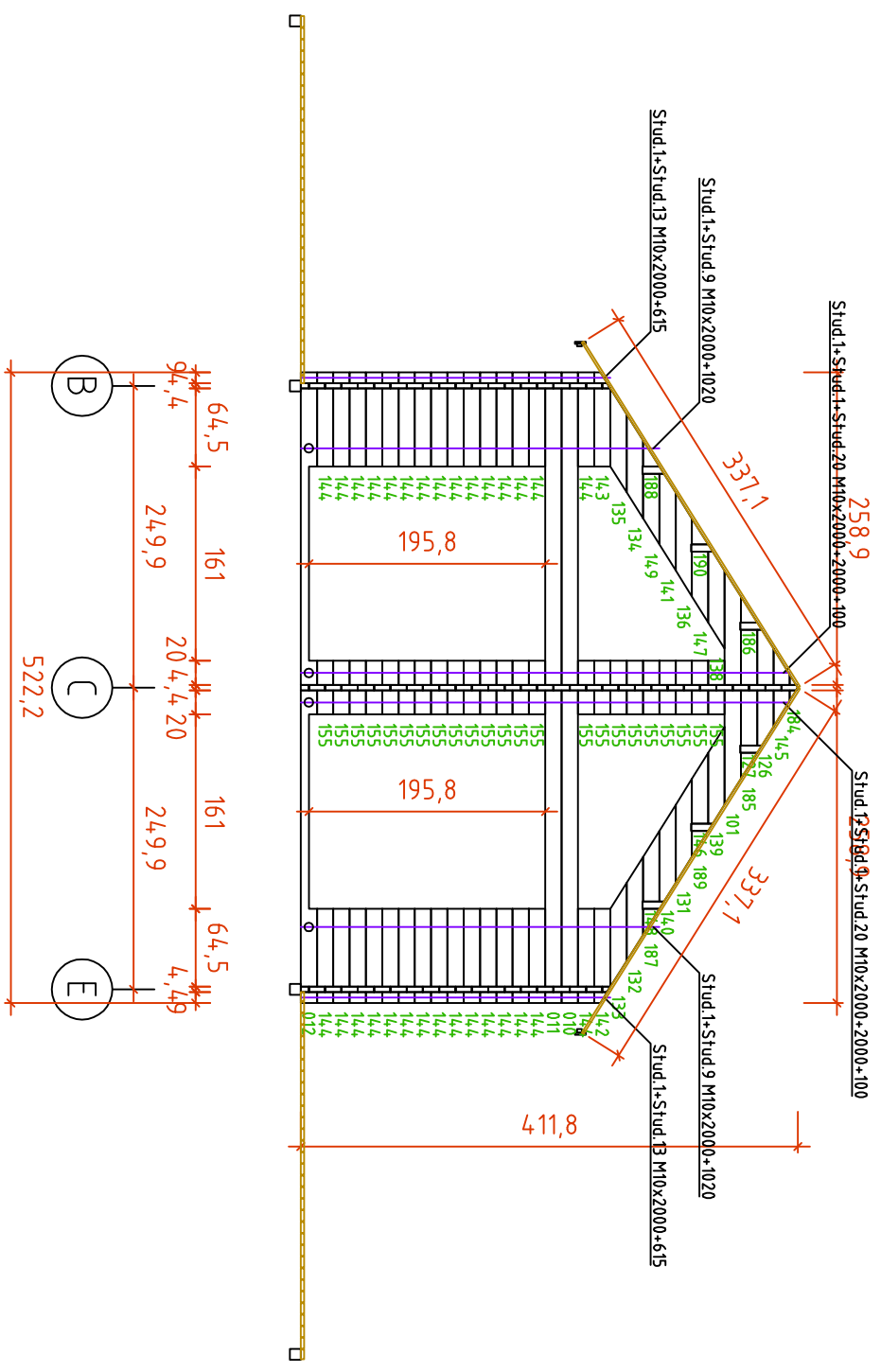

Code	Francia_Carrion		Page	13	03.12.015
Drawing	WALL 6		Scale	1:100	
File	Wall_44+90+19		File	Francia_Carrion.dwg	